



LIGITEK

LIGITEK ELECTRONICS CO.,LTD.
Property of Ligitek Only

DUAL COLOR LED LAMPS



Lead-Free Parts

L9SEFSBKS42292/R1-PF

DATA SHEET

DOC. NO : QW0905-L9SEFSBKS42292/R1-PF

REV. : A

DATE : 12 - May.- 2009





Package Dimensions

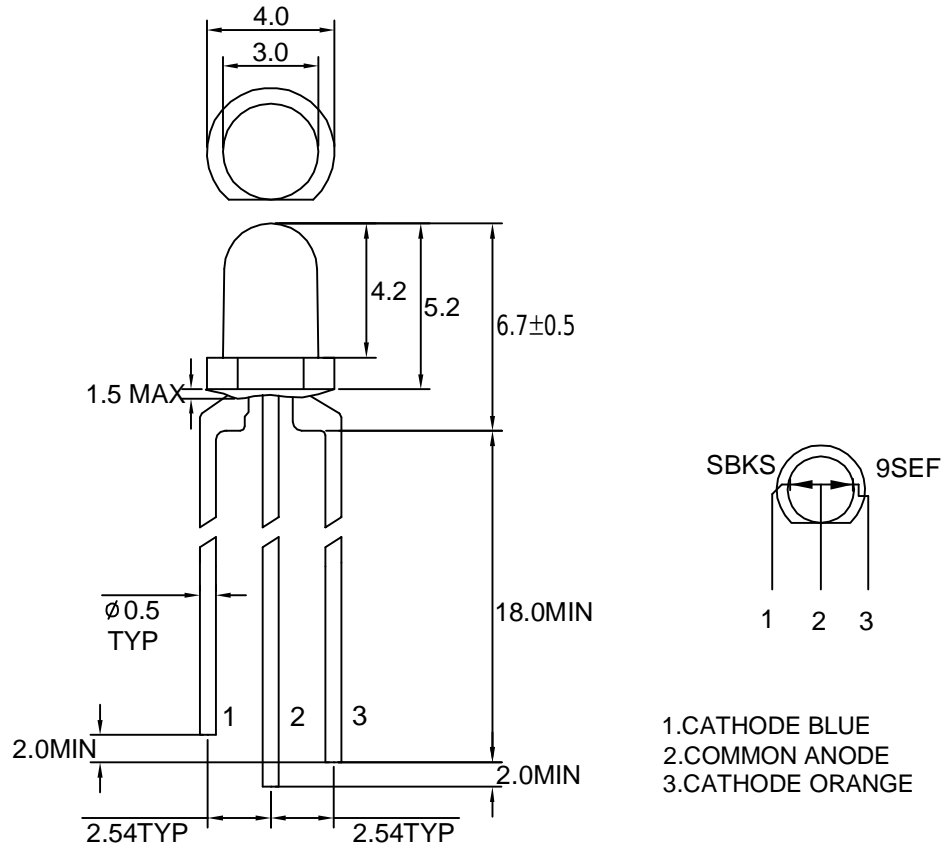

Note : 1.All dimension are in millimeter tolerance is ±0.25mm unless otherwise noted.
2.Specifications are subject to change without notice.

Directivity Radiation

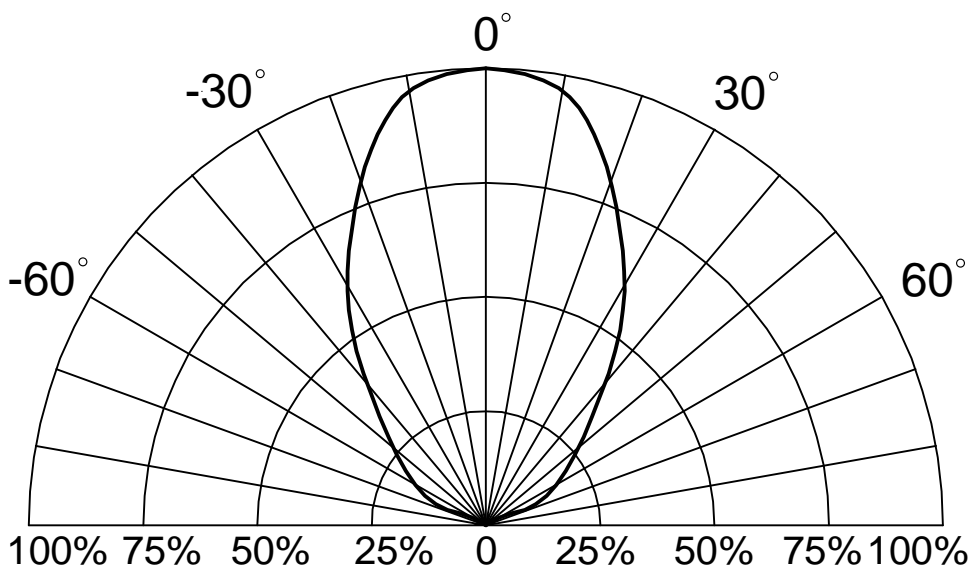



Absolute Maximum Ratings at Ta=25 °C

Parameter	Symbol	Ratings		UNIT
		9SEF	SBKS	
Forward Current	IF	30	30	mA
Peak Forward Current Duty 1/10@10KHz	IFP	60	100	mA
Power Dissipation	PD	75	120	mW
Reverse Current @5V	Ir	10	50	μA
Electrostatic Discharge(*)	ESD	2000	500	V
Operating Temperature	T _{opr}	-20 ~ +80		°C
Storage Temperature	T _{stg}	-30 ~ +100		°C

* Static Electricity or power surge will damage the LED. Use of a conductive wrist band or anti-electrostatic glove is recommended when handling these LED. All devices, equipment and machinery must be properly grounded.

Typical Electrical & Optical Characteristics (Ta=25 °C)

PART NO	MATERIAL	COLOR		Dominant wave length λ Dnm	Spectral halfwidth Δ λ nm	Forward voltage @20mA(V)			Luminous intensity @20mA(mcd)		Viewing angle 2θ 1/2 (deg)
		Emitted	Lens			Min.	Typ.	Max.	Min.	Typ.	
L9SEFSBKS42292/R1-PF	AlGaInP	Orange	White Diffused	605	17	1.7	----	2.6	21	38	70
	InGaN/SiC	Blue		475	26	----	3.5	4.2	9	15	70

Note : 1. The forward voltage data did not including ±0.1V testing tolerance.
2. The luminous intensity data did not including ±15% testing tolerance.



Typical Electro-Optical Characteristics Curve

9SEF CHIP

Fig.1 Forward current vs. Forward Voltage

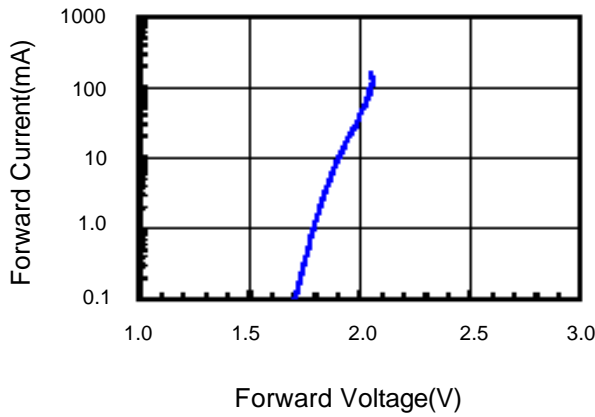

Fig.2 Relative Intensity vs. Forward Current

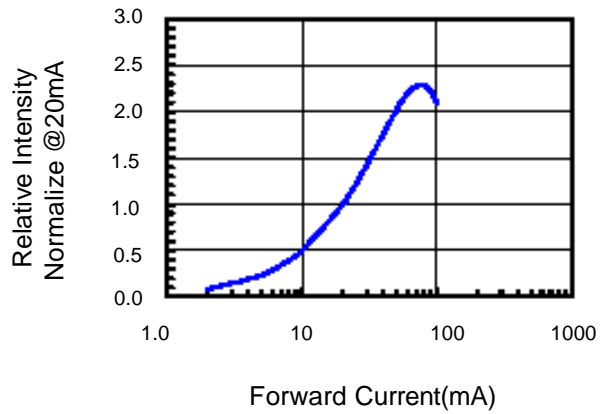

Fig.3 Forward Voltage vs. Temperature

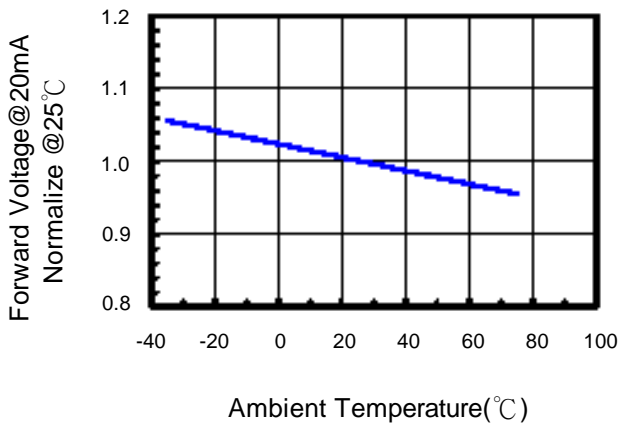

Fig.4 Relative Intensity vs. Temperature

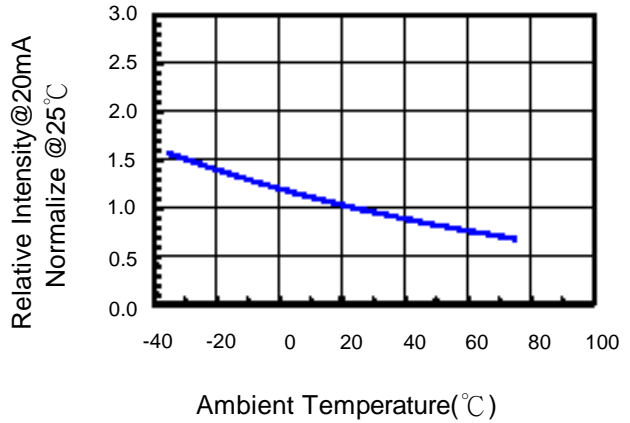
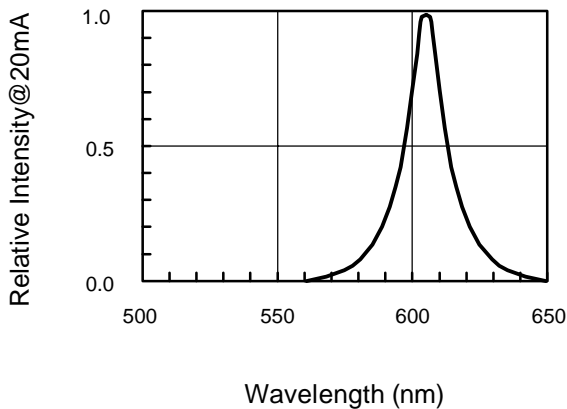

Fig.5 Relative Intensity vs. Wavelength





Typical Electro-Optical Characteristics Curve

SBK-S CHIP

Fig.1 Forward current vs. Forward Voltage

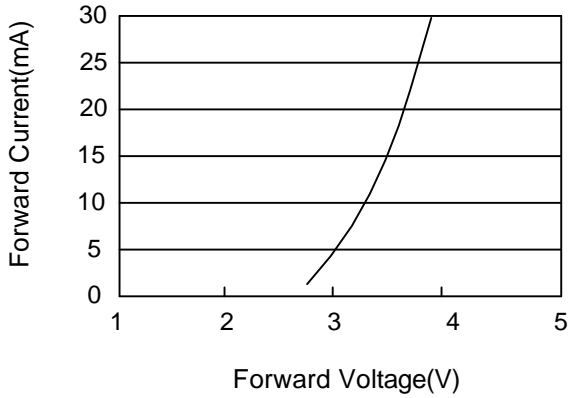

Fig.2 Relative Intensity vs. Forward Current

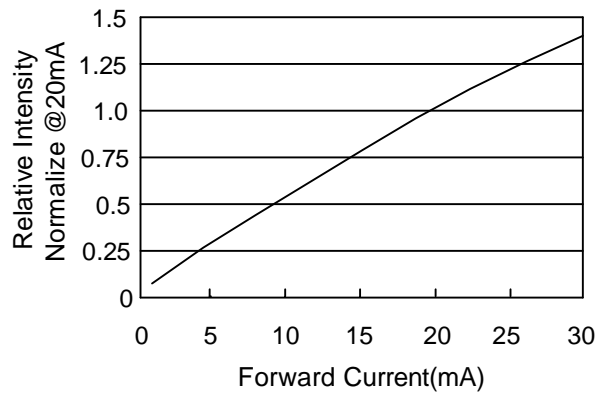

Fig.3 Forward Current vs. Temperature

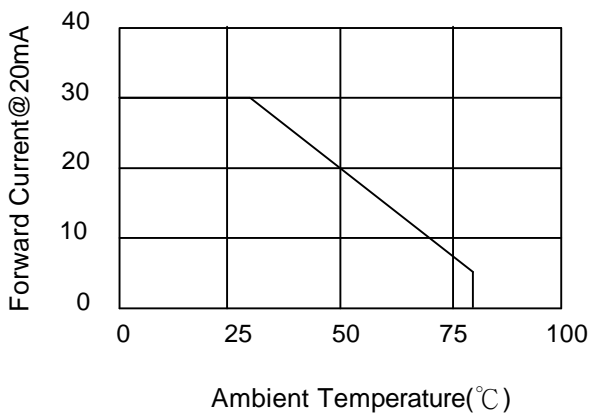
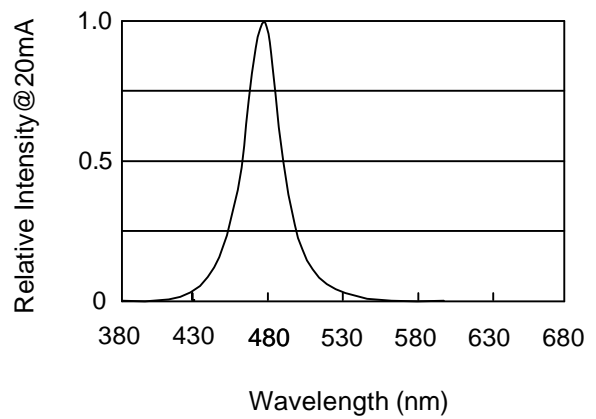

Fig.4 Relative Intensity vs. Wavelength





Soldering Condition(Pb-Free)

1.Iron:

Soldering Iron:30W Max
Temperature 350° C Max
Soldering Time:3 Seconds Max(One time only)
Distance:2mm Min(From solder joint to body)

2.Wave Soldering Profile

Dip Soldering
Preheat: 120° C Max
Preheat time: 60seconds Max
Ramp-up
2° C/sec(max)
Ramp-Down:-5° C/sec(max)
Solder Bath:260° C Max
Dipping Time:3 seconds Max
Distance:2mm Min(From solder joint to body)

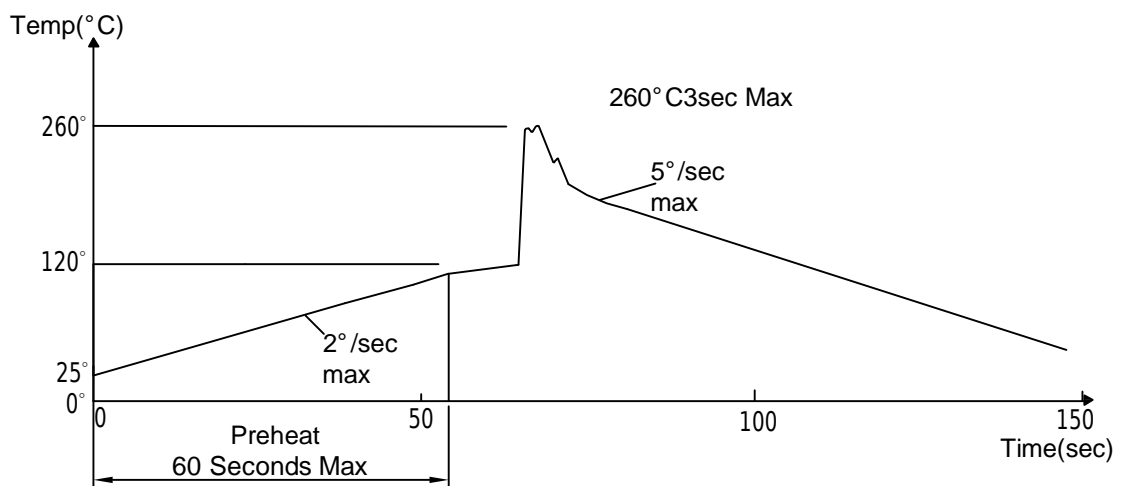

Note: 1.Wave solder should not be made more than one time.
2.You can just only select one of the soldering conditions as above.

**Reliability Test:**

Test Item	Test Condition	Description	Reference Standard
Operating Life Test	1.Under Room Temperature 2.If=20mA 3.t=1000 hrs (-24hrs, +72hrs)	This test is conducted for the purpose of detemining the resistance of a part in electrical and themal stressed.	MIL-STD-750: 1026 MIL-STD-883: 1005 JIS C 7021: B-1
High Temperature Storage Test	1.Ta=105 °C±5°C 2.t=1000 hrs (-24hrs, +72hrs)	The purpose of this is the resistance of the device which is laid under condition of high temperature for hours.	MIL-STD-883:1008 JIS C 7021: B-10
Low Temperature Storage Test	1.Ta=-40 °C±5°C 2.t=1000 hrs (-24hrs, +72hrs)	The purpose of this is the resistance of the device which is laid under condition of low temperature for hours.	JIS C 7021: B-12
High Temperature High Humidity Test	1.Ta=65 °C±5°C 2.RH=90%~95% 3.t=240hrs ±2hrs	The purpose of this test is the resistance of the device under tropical for hours.	MIL-STD-202:103B JIS C 7021: B-11
Thermal Shock Test	1.Ta=105 °C±5°C & -40 °C±5°C (10min) (10min) 2.total 10 cycles	The purpose of this is the resistance of the device to sudden extreme changes in high and low temperature.	MIL-STD-202: 107D MIL-STD-750: 1051 MIL-STD-883: 1011
Solder Resistance Test	1.T.Sol=260 °C±5°C 2.Dwell time= 10 ±1sec.	This test intended to determine the thermal characteristic resistance of the device to sudden exposures at extreme changes in temperature when soldering the lead wire.	MIL-STD-202: 210A MIL-STD-750: 2031 JIS C 7021: A-1
Solderability Test	1.T.Sol=230 °C±5°C 2.Dwell time=5 ±1sec	This test intended to see soldering well performed or not.	MIL-STD-202: 208D MIL-STD-750: 2026 MIL-STD-883: 2003 JIS C 7021: A-2